

User's Manual

EPIA-EN

Version 1.21
September 24, 2008

Copyright

Copyright © 2005-2008 VIA Technologies Incorporated. All rights reserved.

No part of this document may be reproduced, transmitted, transcribed, stored in a retrieval system, or translated into any language, in any form or by any means, electronic, mechanical, magnetic, optical, chemical, manual or otherwise without the prior written permission of VIA Technologies, Incorporated.

Trademarks

All trademarks are the property of their respective holders. PS/2 is a registered trademark of IBM Corporation. Award BIOS is a registered trademark of Phoenix Technologies Ltd.

Macrovision

Apparatus Claims of U.S. Patent Nos. 6,836,549; 6,381,747; 7,050,698; 6,516,132; 5,583,936 licensed for limited viewing uses only. This product incorporates copyright protection technology that is protected by certain U.S. patents and other intellectual property rights owned by Macrovision and other rights owners. Use of this copyright protection technology must be authorized by Macrovision, and is intended for home and other limited viewing uses only unless otherwise authorized by Macrovision. Reverse engineering or disassembly is prohibited.

Disclaimer

No license is granted, implied or otherwise, under any patent or patent rights of VIA Technologies. VIA Technologies makes no warranties, implied or otherwise, in regard to this document and to the products described in this document. The information provided in this document is believed to be accurate and reliable as of the publication date of this document. However, VIA Technologies assumes no responsibility for the use or misuse of the information in this document and for any patent infringements that may arise from the use of this document. The information and product specifications within this document are subject to change at any time, without notice and without obligation to notify any person of such change.

FCC-B Radio Frequency Interference Statement

This equipment has been tested and found to comply with the limits for a class B digital device, pursuant to part 15 of the FCC rules. These limits are designed to provide reasonable protection against harmful interference when the equipment is operated in a commercial environment. This equipment generates, uses and can radiate radio frequency energy and, if not installed and used in accordance with the instruction manual, may cause harmful interference to radio communications. Operation of this equipment in a residential area is likely to cause harmful interference, in which case the user will be required to correct the interference at his personal expense.

Notice 1

The changes or modifications not expressly approved by the party responsible for compliance could void the user's authority to operate the equipment.

Notice 2

Shielded interface cables and A.C. power cord, if any, must be used in order to comply with the emission limits.



Tested To Comply
With FCC Standards
FOR HOME OR OFFICE USE

Safety Instructions

1. Always read the safety instructions carefully.
2. Keep this User's Manual for future reference.
3. Keep this equipment away from humidity.
4. Lay this equipment on a reliable flat surface before setting it up.
5. The openings on the enclosure are for air convection hence protects the equipment from overheating. **DO NOT COVER THE OPENINGS.**
6. Make sure the voltage of the power source and adjust properly 110/220V before connecting the equipment to the power inlet.
7. Place the power cord in such a way that people cannot step on it. Do not place anything over the power cord.
8. Always unplug the power cord before inserting any add-on card or module.
9. All cautions and warnings on the equipment should be noted.
10. Never pour any liquid into the opening. Liquid can cause damage or electrical shock.
11. If any of the following situations arises, get the equipment checked by a service personnel:
 - The power cord or plug is damaged
 - Liquid has penetrated into the equipment
 - The equipment has been exposed to moisture
 - The equipment has not work well or you cannot get it work according to User's Manual.
 - The equipment has dropped and damaged
 - If the equipment has obvious sign of breakage
12. **DO NOT LEAVE THIS EQUIPMENT IN AN ENVIRONMENT UNCONDITIONED, STORAGE TEMPERATURE ABOVE 60 C (140F), IT MAY DAMAGE THE EQUIPMENT.**



Caution:

- Only use the appropriate battery specified for this product.
- Do not reuse, recharge, or reheat an old battery.
- Do not attempt to force open the battery.
- Do not discard used batteries with regular trash.
- Discard used batteries according to local regulations.



Box Contents

- ☒ One VIA Mini-ITX mainboard
- ☒ One Quick Installation Guide
- ☒ One ATA-133/100 IDE ribbon cable
- ☒ One driver and utilities CD
- ☒ One IO bracket

TABLE OF CONTENTS

| | |
|-----------------------------------|----|
| Box Contents..... | i |
| Table of Contents | ii |
| Chapter 1 | 1 |
| Specifications | 1 |
| Mainboard Specifications | 2 |
| Mainboard Layout | 5 |
| Back Panel Layout..... | 6 |
| Back Panel Ports..... | 7 |
| Slots..... | 7 |
| Onboard Connectors..... | 8 |
| Onboard Jumpers..... | 8 |
| Chapter 2 | 9 |
| Installation..... | 9 |
| CPU..... | 10 |
| Memory Module Installation | 12 |
| Connecting the Power Supply | 13 |
| Back Panel Ports..... | 14 |
| Connectors..... | 17 |
| Jumpers..... | 25 |
| Slots..... | 27 |
| Chapter 3 | 29 |
| BIOS Setup | 29 |
| Entering Setup | 30 |
| Control Keys..... | 31 |
| Navigating the BIOS Menus..... | 32 |
| Getting Help..... | 33 |
| Main Menu | 34 |
| Standard CMOS Features | 36 |
| IDE Drives | 37 |
| Advanced BIOS Features..... | 38 |
| CPU Feature | 41 |
| Hard Disk Boot Priority | 44 |
| Advanced Chipset Features | 45 |
| AGP & P2P Bridge Control..... | 48 |

| | |
|--------------------------------------|----|
| CPU & PCI Bus Control | 50 |
| TV Output Connector..... | 51 |
| Integrated Peripherals..... | 52 |
| Super IO Device | 54 |
| Power Management Setup..... | 55 |
| Peripheral Activities | 57 |
| IRQs Activities | 60 |
| PNP/PCI Configurations | 61 |
| IRQ Resources..... | 63 |
| PC Health Status..... | 64 |
| Frequency / Voltage Control..... | 65 |
| Load Fail-Safe Defaults..... | 69 |
| Load Optimized Defaults | 70 |
| Set Supervisor / User Password | 71 |
| Save & Exit Setup | 73 |
| Exit Without Saving..... | 74 |
| Chapter 4 | 75 |
| Driver Installation..... | 75 |
| Driver Utilities | 76 |
| CD Content | 78 |

This page is left intentionally blank.

CHAPTER 1

Specifications

The ultra-compact and highly integrated VIA EPIA-EN uses the Mini-ITX mainboard form-factor developed by VIA Technologies, Inc. as part of the company's open industry-wide total connectivity initiative. The mainboard enables the creation of an exciting new generation of small, ergonomic, innovative and affordable embedded systems. Through a high level of integration, the Mini-ITX occupy 66% of the size of FlexATX mainboard form factor. The mainboard comes with an embedded VIA Processor, boasting of ultra-low power consumption, cool and quiet operation.

MAINBOARD SPECIFICATIONS

CPU

- VIA C7 V4 Bus / Eden V4 Bus NanoBGA2 Processor

Chipset

- VIA CN700 North Bridge
- VIA VT8237R-series South Bridge

Graphics

- Integrated UniChrome™ Pro AGP with MPEG-2 Acceleration

Audio

- VIA VT1618 8-channel AC'97 Codec

Memory

- 1 x DDR2 533/400 DIMM slot (up to 1 GB)

Expansion Slot

- 1 x PCI slot

IDE

- 2 x UltraDMA 133/100 connectors

LAN

- VIA VT1622 1000/100/10 Base-T Ethernet PHY

IEEE 1394

- VIA VT6307S IEEE 1394 Fire Wire

TV-Out

- VIA VT1625M HDTV Encoder

Back Panel I/O Ports

- 1 x PS/2 mouse port and 1 x PS/2 keyboard port
- 1 x RJ-45 LAN port
- 1 x Serial port
- 1 x VGA port
- 4 x USB 2.0 ports
- 1 x RCA port (SPDIF or TV out)
- 1 x S-Video port
- 3 x Audio Jacks: line-out, line-in and mic-in (Horizontal, Smart 5.1 Support)

Onboard I/O Connectors

- 1 x USB pin header for 2 additional USB 2.0 ports
- 1 x IEEE 1394 pin header
- 1 x SIR pin header (IRDA 1.0)
- 1 x Serial port pin header for COM2
- 1 x Front Panel audio pin header (Mic-in and Line-out)
- 2 x S/PDIF connectors (S/PDIF-in and S/PDIF-out)
- 1 x Component (YPbPr) video pin header
- 2 x Serial ATA connectors
- 1 x SM Bus pin header
- 1 x KBMS pin header (KB/MS or CIR)
- 1 x LPC pin header
- 2 x Fan connectors (CPU Fan and System Fan)
- 1 x LVDS/TTL/DVI (an add-on card is required)
- 1 x Front-Panel pin header
- 1 x WP pin header

BIOS

- Award BIOS with 4/8Mbit flash memory capacity
- ACPI2.0, SMBIOS2.1 and DMI2.2

Form Factor

- Mini-ITX (6 layers)
- 17 cm X 17 cm



Note:

Due to the hardware limitation, DDR2 SDRAM chips organized as 128Mb x 8 bank cannot be supported by EPIA products with CN700 and CX700M2 chipsets.

MAINBOARD LAYOUT

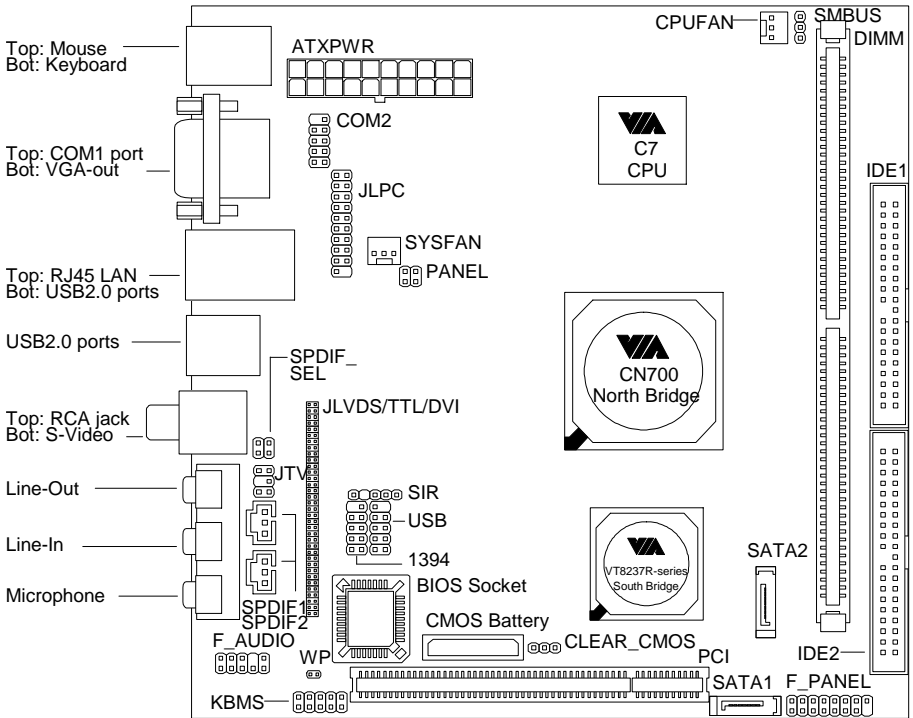

BACK PANEL LAYOUT

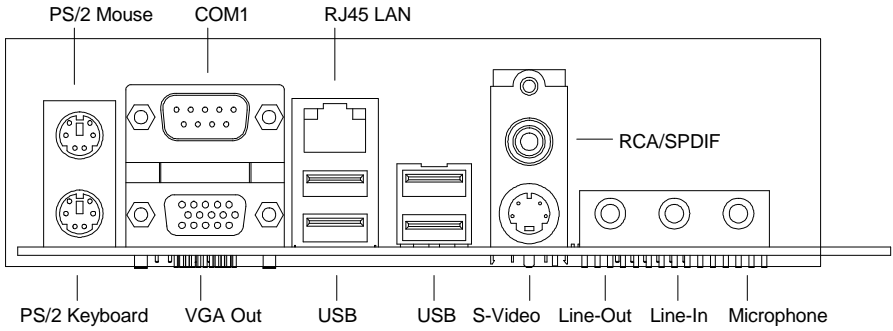

BACK PANEL PORTS

| Port | Description | Page |
|---------------|--|-------------|
| Audio Jacks | 3 Audio ports (line-out, line-in and mic-in) | 13-15 |
| COM1 | Serial port 1 | 13 |
| PS/2 Mouse | PS/2 mouse port | 13 |
| PS/2 Keyboard | PS/2 keyboard port | 13 |
| RCA/SPDIF | RCA port (SPDIF or TV out) | 13-14 |
| RJ45 | RJ45 port | 13-14 |
| USB | USB 2.0 ports | 13-14 |
| VGA | VGA port | 13 |
| S-Video | S-Video port | 13-14 |

SLOTS

| Port | Description | Page |
|-------------|---------------------|-------------|
| DDR DIMM | Memory module slot | 11 |
| PCI | Expansion card slot | 26 |

ONBOARD CONNECTORS

| Connector | Description | Page |
|------------------|---|-------------|
| 1394 | IEEE 1394 connector | 19 |
| ATXPWR | Power cable connector | 12 |
| COM 2 | COM port 2 connector | 20 |
| CPUFAN | CPU fan connector | 10 |
| SIR | Fast Infrared Radiation connector | 19 |
| F_AUDIO | Front Audio connector | 20 |
| F_PANEL | Front panel connector | 17 |
| IDE 1-2 | IDE drive connectors | 16 |
| KBMS | Keyboard and Mouse connector | 22 |
| LPC/SIR | LPC/SIR connector | 23 |
| LVDS/TTL/DVI | LVDS/TTL/DVI connector | 21-22 |
| SATA 1-2 | Serial ATA 1 and 2 connectors | 18 |
| SPDIF 1-2 | SPDIF In/Out connectors | 18 |
| SMBus | SMBus connector | 18 |
| SYSFAN | System fan connector | 10 |
| USB 5-6 | Universal Serial Bus 2.0 connectors 3-4 | 19 |
| TV | TV output connector | 22 |

ONBOARD JUMPERS

| Jumper | Description | Page |
|---------------|-------------------------------|-------------|
| CLEAR_CMOS | Reset CMOS settings | 24 |
| PANEL | IDE selector | 25 |
| SPDIF_SEL | S/SPDIF selector | 24 |
| WP | BIOS write protection setting | 25 |

CHAPTER 2

Installation

This chapter provides you with information about hardware installation procedures. It is recommended to use a grounded wrist strap before handling computer components. Electrostatic discharge (ESD) can damage some components.

CPU

The VIA EPIA-EN Mini-ITX mainboard includes an embedded VIA C7 or Eden V4 Bus Processor. The VIA Eden V4 Bus Processor provides ultra-low power consumption and advanced thermal dissipation properties and features a fanless design. The VIA C7 or Eden V4 Bus Processor requires only a heatsink to provide sufficient cooling.

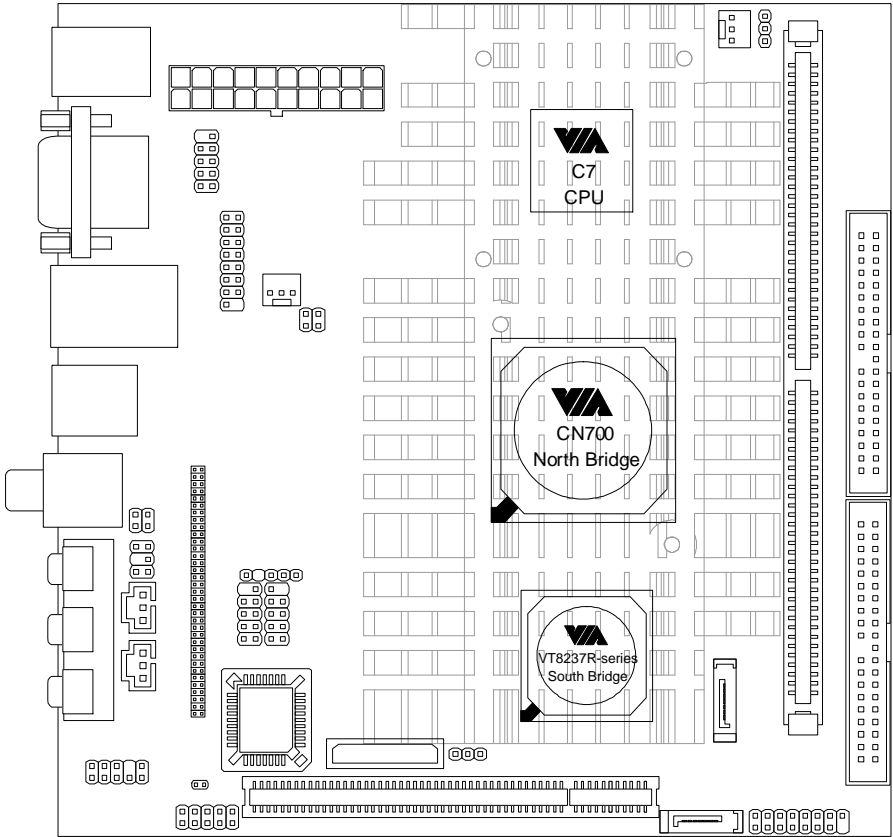

CPU Fan and System Fan: CPUFAN and SYSFAN

The CPUFAN (CPU fan) and SYSFAN (system fan) run on +12V and maintain system cooling. When connecting the wire to the connectors, always be aware that the red wire is the Positive and should be connected to the +12V. The black wire is Ground and should always be connected to GND.

FAN_MCM is a switch that is used by high-quality fans to monitor the system temperature and will automatically adjust according to the environment.

CPUFAN

| Pin | Signal |
|-----|---------|
| 1 | FAN_MCM |
| 2 | +12V |
| 3 | GND |

CPUFAN

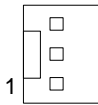

SYSFAN

| Pin | Signal |
|-----|---------|
| 1 | FAN_MCM |
| 2 | +12V |
| 3 | GND |

SYSFAN

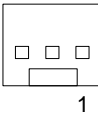

MEMORY MODULE INSTALLATION

The VIA EPIA-EN Mini-ITX mainboard provides one 240-pin DIMM slot for DDR2 533/400 SDRAM memory modules and supports the memory size up to 1GB.

DIMM

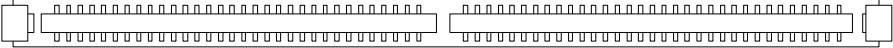

DDR SDRAM Module Installation Procedures

- Locate the DIMM slot in the motherboard.
- Unlock a DIMM slot by pressing the retaining clips outward.
- Align a DIMM on the socket such that the notch on the DIMM matches the break on the slot.
- Firmly insert the DIMM into the slot until the retaining clips snap back in place and the DIMM is properly seated.

Available DDR SDRAM Configurations

Refer to the table below for available DDR SDRAM configurations on the mainboard.

| Slot | Module Size | Total |
|---------------------------------|--------------------------------|----------|
| DIMM | 64MB, 128MB, 256MB, 512MB, 1GB | 64MB-1GB |
| Maximum supported system memory | | 64MB-1GB |

CONNECTING THE POWER SUPPLY

The VIA EPIA-EN Mini-ITX mainboard supports a conventional ATX power supply for the power system. Before inserting the power supply connector, always make sure that all components are installed correctly to ensure that no damage will be caused.

ATX 20-Pin Power Connector

To connect the ATX power supply, make sure the power plug is inserted in the proper orientation and the pins are aligned. Then push down the plug firmly into the connector.

| Pin | Signal |
|-----|-----------------|
| 1 | +3.3V |
| 2 | +3.3V |
| 3 | GND |
| 4 | +5V |
| 5 | GND |
| 6 | +5V |
| 7 | GND |
| 8 | Power Good |
| 9 | +5V Standby |
| 10 | +12V |
| 11 | +3.3V |
| 12 | -12V |
| 13 | GND |
| 14 | Power Supply On |
| 15 | GND |
| 16 | GND |
| 17 | GND |
| 18 | NC |
| 19 | +5V |
| 20 | +5V |

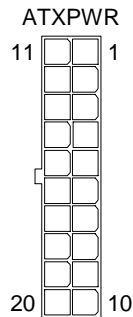

BACK PANEL PORTS

The back panel has the following ports:

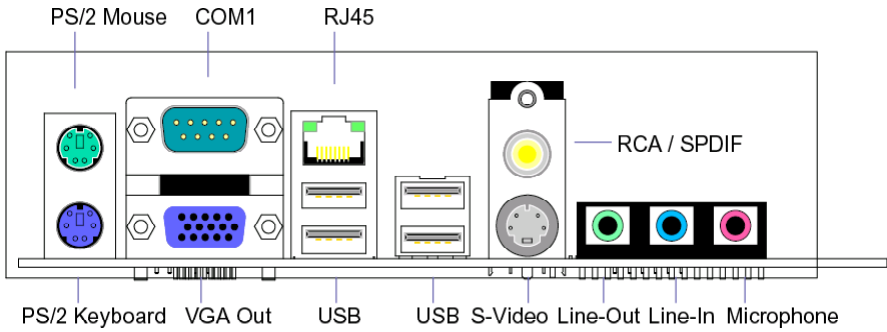

Keyboard and Mouse

The green 6-pin connector is for a PS/2 mouse. The purple connector is for a PS/2 keyboard.

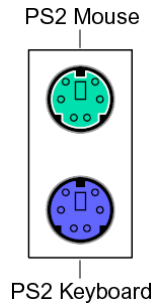

Serial port: COM 1

The green 9-pin COM 1 port is for pointing devices or other serial devices.

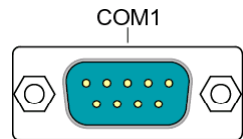

VGA Out

The blue 15-pin female VGA connector can be used to connect to any analog VGA monitor.

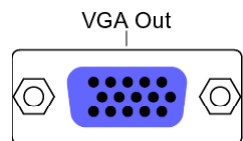

RJ45 10/100 LAN and USB Connector

The mainboard provides a standard RJ-45 and USB 2.0 ports. These ports allow connection to a Local Area Network (LAN) through a network hub and USB 2.0 devices.

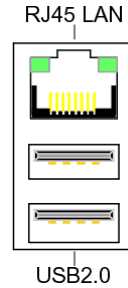

USB 2.0 ports

These two 4-pin Universal Serial Bus (USB) ports are available for connecting USB 2.0 devices.

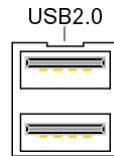

RCA / SPDIF jack

The yellow jack connects to external composite video device or audio output device.

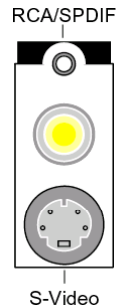

S-Video port

The black port allows you to connect TV monitor or S-video device to the mainboard.

Audio Port:

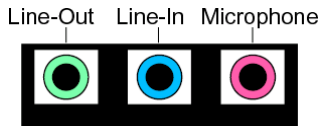

The Line-Out jack is for connecting to external speakers or headphones. The Line-In jack is for connecting to an external audio device such as a CD player, tape player, etc. The Mic jack is for connecting to a microphone.



Note:
The audio ports can be switched to Smart 5.1 6-channel audio output. You can enable the function by clicking the “Vinyl Audio” icon on your desktop after installing the audio driver.

After completing the previous installation, connect the speakers to the 3-jack connectors on the back panel.

Shown below are the corresponding connections to setup the 6-channel system.

| Jack | 2-channel | 6-channel |
|-------------|------------------|--------------------|
| Line-out | Line-out | Front (Left/Right) |
| Line-in | Line-in | Rear (Left/Right) |
| Microphone | Microphone | Center/Sub-woofer |

CONNECTORS

Hard Disk Connectors: IDE1 & IDE2

The mainboard has a 32-bit Enhanced IDE and Ultra DMA 133/100 controller that provides PIO mode 0~4, Bus Master, and Ultra DMA 133/100 functions. You can connect up to four hard disk drives, CD-ROM and other devices.

The primary hard drive should always be connected to IDE1 as the master drive. Both IDE drives can connect to a master and a slave drive.

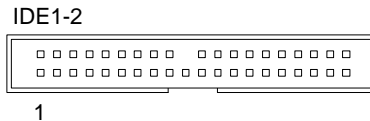

If two drives are connected to a single cable, the jumper on the second drive must be set to slave mode. Refer to the drive documentation supplied by the vendor for the jumper settings.

Case Connector: F_PANEL

The F_PANEL pin header allows you to connect the power switch, reset switch, power LED, sleep LED, HDD LED and the case speaker.

| Pin | Signal |
|-----|---------|
| 1 | +5VDUAL |
| 3 | +5VDUAL |
| 5 | -PLED |
| 7 | +5V |
| 9 | NC |
| 11 | NC |
| 13 | SPEAK |
| 15 | Key |

| Pin | Signal |
|-----|------------|
| 2 | +5V |
| 4 | HD_LED |
| 6 | PW_BN |
| 8 | GND |
| 10 | RST_SW |
| 12 | GND |
| 14 | +5V |
| 16 | -SLEEP_LED |

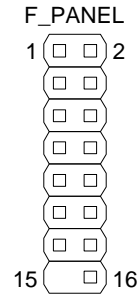

Power Switch (PW_BN)

Connect to a 2-pin power button switch. Pressing this button will turn the system power on or off.

Reset Switch (RST_SW)

The reset switch is used to reboot the system rather than turning the power ON/OFF. Avoid rebooting the system, if the HDD is still working. Connect the reset switch from the system case to this pin.

Power LED (-PLED)

The LED will light when the system is on. If the system is in S1 (POS - Power On Suspend) or S3 (STR - Suspend To RAM) state, the LED will blink.

HDD LED (HD_LED)

HDD LED shows the activity of a hard disk drive. Avoid turning the power off when the HDD LED still has a lit. Connect the HDD LED from the system case to this pin.

Speaker

The speaker from the system case is connected to this pin.

Serial ATA Connectors: SATA1 and SATA2

These next generation connectors support the thin Serial ATA cables for primary internal storage devices. The current Serial ATA interface allows up to 150MB/s data transfer rate, faster than the standard parallel ATA with 133 MB/s (Ultra DMA).

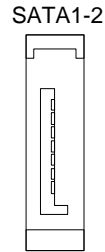

Digital Audio Connectors: S/PDIF1 and S/PDIF2

These connectors for connecting the Sony Philips Digital Interface (S/PDIF) bracket. The S/PDIF output provides digital audio to external speakers or compressed AC3 data to an external Dolby Digital Decoder. The feature is available only with stereo system that has digital output function.

SPDIF1

| Pin | Signal |
|-----|------------|
| 1 | +5V |
| 2 | S/PDIF Out |
| 3 | GND |

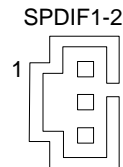

SPDIF2

| Pin | Signal |
|-----|-----------|
| 1 | +5V |
| 2 | S/PDIF In |
| 3 | GND |

System Management Bus Connector: SMBus

This pin header allows you to connect SMBus (System Management Bus) devices. Devices communicate with an SMBus host and/or other SMBus devices using the SMBus interface.

| Pin | Signal |
|-----|--------|
| 1 | SMBCK |
| 2 | SMBDT |
| 3 | GND |

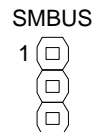

USB Pin Connector: USB 5-6

The mainboard provides 1 front USB pin header, allowing up to 2 additional USB2.0 ports up to maximum throughput of 480 Mbps. Connect each 2-port USB cable into this pin header. This port can be used to connect high-speed USB interface peripherals such as USB HDD, digital cameras, MP3 players, printers, modem and the like.

| Pin | Signal |
|-----|----------|
| 1 | USBVCC |
| 3 | USBD_T5- |
| 5 | USBD_T5+ |
| 7 | GND |
| 9 | Key |

| Pin | Signal |
|-----|----------|
| 2 | USBVCC |
| 4 | USBD_T6- |
| 6 | USBD_T6+ |
| 8 | GND |
| 10 | GND |

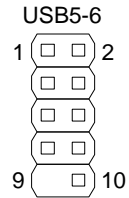

FireWire Connector: IEEE1394

FireWire is a serial I/O interface that provides you fast data transfer rates. The mainboard has one FireWire pin header to provide PC connectivity for a wide range of devices, including consumer electronics audio/video (A/V) appliances, storage peripherals, other PCs and portable devices.

| Pin | Signal |
|-----|----------|
| 1 | TPA0+ |
| 3 | GND |
| 5 | TB0+ |
| 7 | 1394_VDD |
| 9 | GND |

| Pin | Signal |
|-----|----------|
| 2 | TPA0- |
| 4 | GND |
| 6 | TPB0- |
| 8 | 1394_VDD |
| 10 | Key |

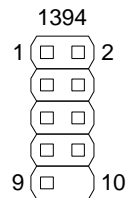

Fast IrDA Infrared Module Connector: SIR

This pin header is used to connect to an IrDA module. The BIOS settings must be configured to activate the IR function.

| Pin | Signal |
|-----|--------|
| 1 | +5V |
| 2 | Key |
| 3 | IRRX |
| 4 | GND |
| 5 | IRTX |

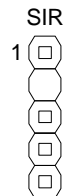

Serial Port Connector: COM 2

COM2 pin header can be used to attach additional port for serial mouse or another serial device.

| Pin | Signal |
|-----|--------|
| 1 | DCD |
| 3 | SOUT |
| 5 | GND |
| 7 | RTS |
| 9 | RI |

| Pin | Signal |
|-----|--------|
| 2 | SIN |
| 4 | DTR |
| 6 | DSR |
| 8 | CTS |
| 10 | Key |

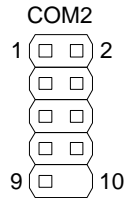

Front Panel Audio Connector: F_AUDIO

This is an interface for the VIA front panel audio cable that allow convenient connection and control of audio devices. By default, the pins labeled LINE_OUT_R/NEXT_R and the pins LINE_OUT_L/NEXT_L are shorted with jumper caps. Remove the caps only when you are connecting the front panel audio cable.

| Pin | Signal |
|-----|------------|
| 1 | FRNMIC |
| 3 | MIC_BIAS |
| 5 | LINE_OUT_R |
| 7 | NC |
| 9 | LINE_OUT_L |

| Pin | Signal |
|-----|-----------|
| 2 | AGND |
| 4 | +5V AUDIO |
| 6 | NEXT_R |
| 8 | Key |
| 10 | NEXT_L |

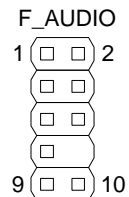

Note:

If you don't want to connect to the front audio header, pins 5 & 6, 9 & 10 have to be jumpered in order to have signal output directed to the rear audio ports. Otherwise, the Line-Out connector on the back panel will not function.

LVDS/TTL/DVI Connector: LVDS/TTL/DVI

This connector works as the interface to multi display devices. An additional daughter card is required for a certain display support. Daughter cards for LVDS and DVI are currently available respectively.

| Pin | Signal | Pin | Signal |
|-----|----------|-----|----------|
| 1 | DVID0 | 2 | DVID1 |
| 3 | DVID2 | 4 | DVID3 |
| 5 | DVID4 | 6 | DVID5 |
| 7 | DVID6 | 8 | DVID9 |
| 9 | DVID8 | 10 | DVID7 |
| 11 | DVID10 | 12 | DVID11 |
| 13 | DVIDE | 14 | DVICLK |
| 15 | DVIVS | 16 | NC |
| 17 | DVIHS | 18 | NC |
| 19 | GND | 20 | GND |
| 21 | +12V | 22 | +5V |
| 23 | +12V | 24 | +5V |
| 25 | GND | 26 | GND |
| 27 | +3.3V | 28 | GND |
| 29 | ENPVEE | 30 | GND |
| 31 | FPBKLP | 32 | ENPVDD |
| 33 | GFPD13 | 34 | GFPDE |
| 35 | GND | 36 | GFPD17 |
| 37 | GFPD23 | 38 | GND |
| 39 | GFPVS | 40 | GFPHS |
| 41 | GFPD2 | 42 | +5V |
| 43 | GFPD11 | 44 | GFPD21 |
| 45 | GFPD7 | 46 | GFPD10 |
| 47 | +3.3V | 48 | GFPD20 |
| 49 | +3.3V | 50 | Key |
| 51 | GFPD9 | 52 | GFPCLK |
| 53 | Key | 54 | NC |
| 55 | GFPD12 | 56 | GND |
| 57 | GFPD15 | 58 | GND |
| 59 | GFPD14 | 60 | GND |
| 61 | GFPD16 | 62 | GND |
| 63 | GFPD18 | 64 | GFPD22 |
| 65 | GFPD19 | 66 | GFPD1 |
| 67 | GFPD0 | 68 | GFPD3 |
| 69 | GND | 70 | GFPD4 |
| 71 | GND | 72 | GFPD6 |
| 73 | GFPD8 | 74 | GFPD5 |
| 75 | GND | 76 | GND |
| 77 | DVI_SBDT | 78 | DVI_SBCK |
| 79 | PWRGD_SB | 80 | GND |

LVDS/TTL/DVI

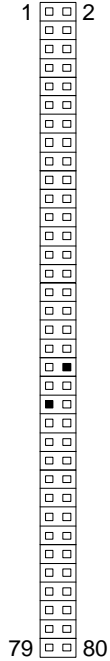

**Note:**

ENPVDD: Enable Panel VDD power
 ENVEE: Enable panel VEE power
 GFPD: Graphic Flat Panel Device signals

YPbPr Connector: JTV

This pin header is for YPbPr (Component TV output connector) signals.

| Pin | Signal |
|-----|--------|
| 1 | Y |
| 2 | GND |
| 3 | Pr |
| 4 | Key |
| 5 | Pb |
| 6 | GND |

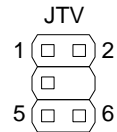
**KBMS Connector: KBMS**

The mainboard provides a PS2 pin header to attach a PS2 keyboard and mouse.

| Pin | Signal | Pin | Signal |
|-----|-----------|-----|------------|
| 1 | +5V Dual | 2 | GND |
| 3 | KB_CLK | 4 | KB_DATA |
| 5 | EKBCLK | 6 | EKBDATA |
| 7 | Mouse_CLK | 8 | Mouse_DATA |
| 9 | EMSCLK | 10 | EMSDATA |

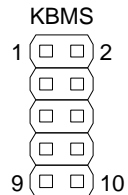
**Note:**

When the pin header is not in use, please short pin 3&5, pin 4&6, pin 7&9 and pin 8&10.

LPC / SIR Connector: JLPC

This pin connector is for LPC / SIR devices.

| Pin | Signal |
|-----|----------|
| 1 | LAD1 |
| 3 | -PCIRSTX |
| 5 | LAD0 |
| 7 | LAD2 |
| 9 | SERIRQ |
| 11 | -LDRQ1 |
| 13 | +5V |
| 15 | +5V |
| 17 | IRTX |
| 19 | GND |

| Pin | Signal |
|-----|---------|
| 2 | LPCCLK1 |
| 4 | GND |
| 6 | SIO_OSC |
| 8 | -LFRAME |
| 10 | LAD3 |
| 12 | -EXTSMI |
| 14 | +3.3V |
| 16 | +3.3V |
| 18 | IRRX |
| 20 | Key |

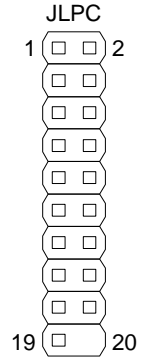

JUMPERS

The mainboard provides jumpers for setting some mainboard functions. This section will explain how to change the settings of the mainboard functions using the jumpers.

Clear CMOS: CLEAR_CMOS

The onboard CMOS RAM stores system configuration data and has an onboard battery power supply. To reset the CMOS settings, set the jumper on pins 2 and 3 while the system is off. Return the jumper to pins 1 and 2 afterwards. Setting the jumper while the system is on will damage the mainboard.

| Setting | 1 | 2 | 3 |
|--------------------|-----|----|-----|
| Clear CMOS setting | OFF | ON | ON |
| Keep CMOS setting | ON | ON | OFF |



Caution:

Except when clearing the RTC RAM, never remove the cap on CLEAR_CMOS jumper default position. Removing the cap will cause system boot failure. Avoid clearing the CMOS while the system is on; it will damage the mainboard.

SPDIF/COMP Select: SPDIF_SEL

This jumper is for selecting between SPDIF and RCA (composite) video.

| Setting | 1 | 2 | 3 | 4 |
|---------------|-----|-----|-----|-----|
| RCA Composite | ON | ON | OFF | OFF |
| SPDIF | OFF | OFF | ON | ON |

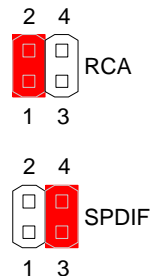

AGP/DVI Port Select: PANEL

This jumper is for selecting between AGP Port Muxing and Dedicated DVI Port Configuration.

| Setting | 1 | 2 | 3 | 4 |
|-------------|-----|-----|-----|-----|
| TVD4/DVPOD4 | ON | ON | OFF | OFF |
| TVD5/DVPOD5 | OFF | OFF | ON | ON |

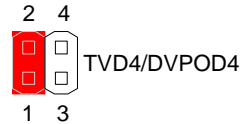

Note:
 TVD4/DVPOD4 – AGP Port Muxing (ON: 2 12-bit DVI interface, OFF: 1 24-bit Panel interface)
 TVD5/DVPOD5 – Dedicated DVI Port Configuration (ON: TMDS Encoder, OFF: TV Encoder)

BIOS Write Protection: WP

This jumper allows you to protect from flashing the BIOS. BIOS Write Protection setting: pin1 = /WP & /TBL, pin2 = GND, short 1-2 (default)



SLOTS

Peripheral Component Interconnect: PCI

The PCI slot allows you to insert PCI expansion card. When adding or removing expansion card, unplug first the power supply. Read the documentation for the expansion card if any changes to the system are necessary.

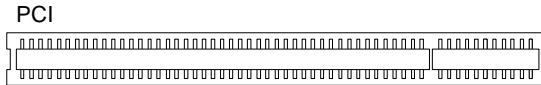

PCI Interrupt Request Routing

The IRQ (interrupt request line) are hardware lines over which devices can send interrupt signals to the microprocessor. The "PCI & LAN" IRQ pins are typically connected to the PCI bus INT A# ~ INT D# pins as follows:

| | Order 1 | Order 2 | Order 3 | Order 4 |
|------------|----------------|----------------|----------------|----------------|
| PCI Slot 1 | INT B# | INT C# | INT D# | INT A# |
| IEEE1394 | INT B# | | | |

CHAPTER 3

BIOS Setup

This chapter gives a detailed explanation of the BIOS setup functions.

ENTERING SETUP

Power on the computer and press <Delete> during the beginning of the boot sequence to enter the BIOS setup menu. If you missed the BIOS setup entry point, you may restart the system and try again.

CONTROL KEYS

| Keys | Description |
|---------------|---|
| Up Arrow | Move to the previous item |
| Down Arrow | Move to the next item |
| Left Arrow | Move to the item in the left side |
| Right Arrow | Move to the item in the right side |
| Enter | Select the item |
| Escape | Jumps to the Exit menu or returns to the main menu from a submenu |
| Page Up / + | Increase the numeric value or make changes |
| Page Down / - | Decrease the numeric value or make changes |
| F1 | General help, only for Status Page Setup Menu and Option Page Setup Menu |
| F5 | Restore the previous CMOS value from CMOS, only for Option Page Setup Menu |
| F6 | Load the default CMOS value from Fail-Safe default table, only for Option Page Setup Menu |
| F7 | Load Optimized defaults |
| F9 | Jumps to the Main Menu |
| F10 | Save all the CMOS changes and exit |

NAVIGATING THE BIOS MENUS

The main menu displays all the BIOS setup categories. Use the control keys Up/Down arrow keys to select any item/sub-menu. Description of the selected/highlighted category is displayed at the bottom of the screen.

An arrow symbol next to a field indicates that a sub-menu is available (see figure below). Press <Enter> to display the sub-menu. To exit the sub-menu, press <Esc>.

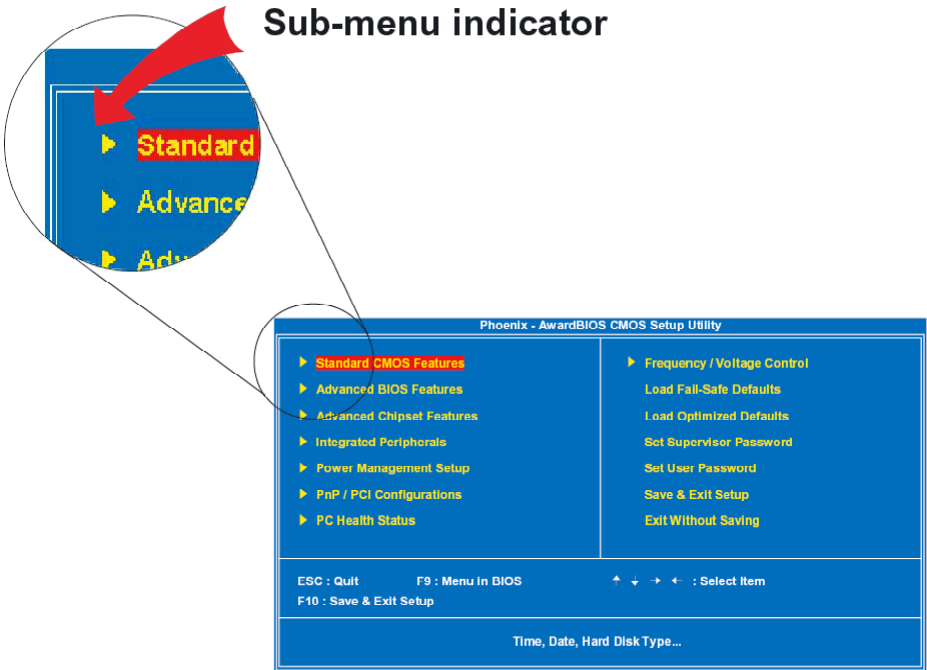

GETTING HELP

The BIOS setup program provides a "General Help" screen. You can display this screen from any menu/sub-menu by pressing <F1>. The help screen displays the keys for using and navigating the BIOS setup. Press <Esc> to exit the help screen.

MAIN MENU

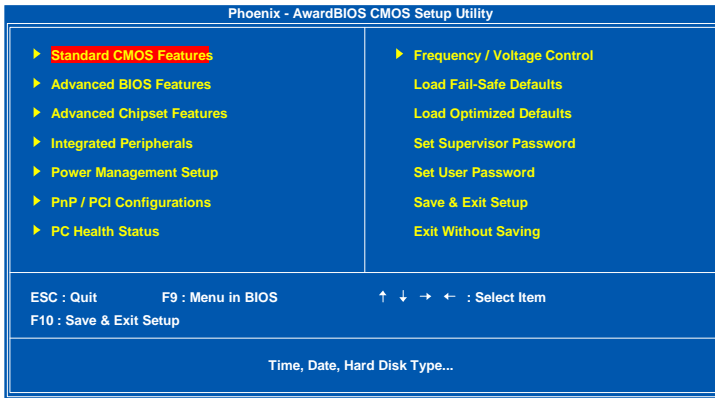

Standard CMOS Features

Use this menu to set basic system configurations.

Advanced BIOS Features

Use this menu to set the advanced features available on your system.

Advanced Chipset Features

Use this menu to set chipset specific features and optimize system performance.

Integrated Peripherals

Use this menu to set onboard peripherals features.

Power Management Setup

Use this menu to set onboard power management functions.

PnP/PCI Configurations

Use this menu to set the PnP and PCI configurations.

PC Health Status

This menu shows the PC health status.

Frequency/Voltage Control

Use this menu to set the system frequency and voltage control.

Load Fail-Safe Defaults

Use this menu option to load the BIOS default settings for minimal and stable system operations.

Load Optimized Defaults

Use this menu option to load BIOS default settings for optimal and high performance system operations.

Set Supervisor Password

Use this menu option to set the BIOS supervisor password.

Set User Password

Use this menu option to set the BIOS user password.

Save & Exit Setup

Save BIOS setting changes and exit setup.

Exit Without Saving

Discard all BIOS setting changes and exit setup.

STANDARD CMOS FEATURES

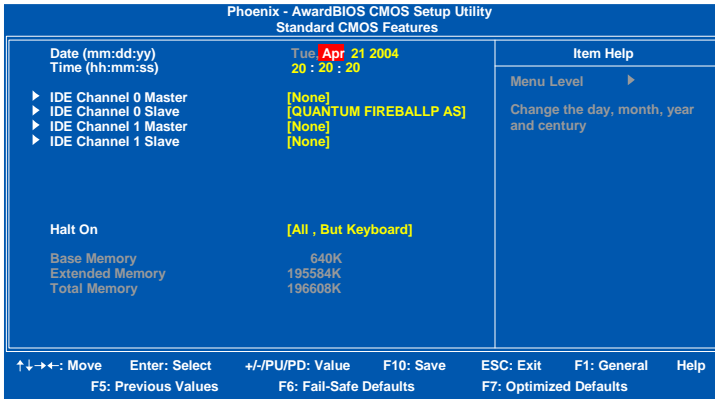

Date

The date format is [Day, Month Date Year]

Time

The time format is [Hour : Minute : Second]

Halt On

Sets the system’s response to specific boot errors. Below is a table that details the possible settings.

| Setting | Description |
|-------------------|---|
| All Errors | System halts when any error is detected |
| No Errors | System does not halt for any error |
| All, But Keyboard | System halts for all non-key errors |

IDE DRIVES

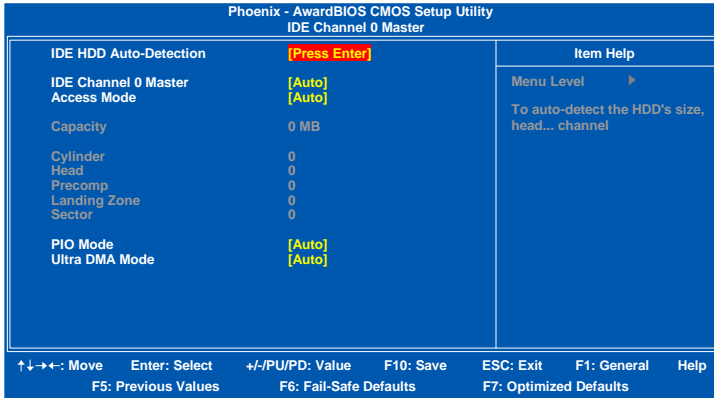

The specifications of your drive must match with the drive table. The hard disk will not work properly if you enter incorrect information in this category. Select "Auto" whenever possible. If you select "Manual", make sure the information is from your hard disk vendor or system manufacturer. Below is a table that details required hard drive information when using the "Manual" mode.

| Setting | Description |
|----------------|---|
| IDE Channel | The name of this match the name of the menu. Settings: [None, Auto, Manual] |
| Access Mode | Settings: [CHS, LBA, Large, Auto] |
| Capacity | Formatted size of the storage device |
| Cylinder | Number of cylinders |
| Head | Number of heads |
| Precomp | Write precompensation |
| Landing Zone | Cylinder location of the landing zone |
| Sector | Number of sectors |
| PIO Mode | Settings: [0, 1, 2, 3, 4] |
| Ultra DMA Mode | Settings: [Disabled, Auto] |

ADVANCED BIOS FEATURES

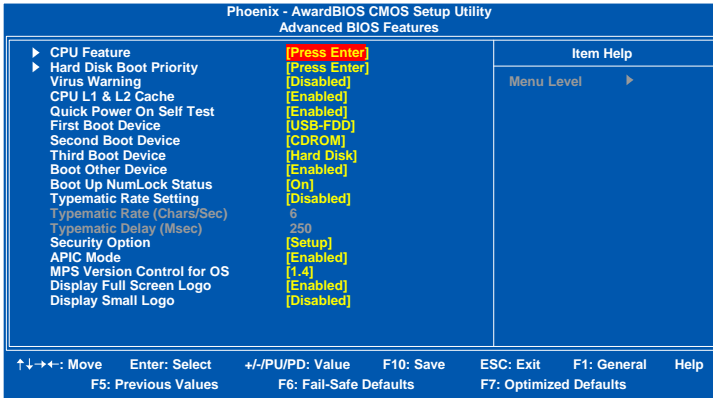

Virus Warning

| Setting | Description |
|----------|--|
| Enabled | Turns on hard disk boot sector virus protection |
| Disabled | Turns off hard disk boot sector virus protection |

CPU L1 & L2 Cache

| Setting | Description |
|----------|-----------------------------|
| Enabled | Turns on CPU L1 & L2 cache |
| Disabled | Turns off CPU L1 & L2 cache |

Quick Power On Self-Test

Shortens Power On Self-Test (POST) cycle to enable shorter boot up time.

| Setting | Description |
|----------|---|
| Enabled | Shorten Power On Self Test (POST) cycle and bootup time |
| Disabled | Standard Power On Self Test (POST) |

First/Second/Third Boot Device

Set the boot device sequence as BIOS attempts to load the disk operating system.

| Setting | Description |
|------------|----------------------------------|
| LS120 | Boot from LS-120 drive |
| Hard Disk | Boot from the HDD |
| CD-ROM | Boot from CD-ROM |
| ZIP100 | Boot from ATAPI ZIP drive |
| USB-FDD | Boot from USB floppy drive |
| USB-ZIP | Boot from USB ZIP drive |
| USB-CDROM | Boot from USB CDROM |
| Legacy LAN | Boot from network drive |
| Disabled | Disable the boot device sequence |

Boot Other Device

Enables the system to boot from alternate devices if the system fails to boot from the "First/Second/Third Boot Device" list.

| Setting | Description |
|----------|----------------------------------|
| Enabled | Enable alternate boot device |
| Disabled | No alternate boot device allowed |

Boot Up NumLock Status

Set the NumLock status when the system is powered on.

| Setting | Description |
|---------|---------------------------------------|
| On | Forces keypad to behave as 10-key |
| Off | Forces keypad to behave as arrow keys |

Typematic Rate Setting

Enables "Typematic Rate" and "Typematic Delay" functions.

Settings: [Enabled, Disabled]

Typematic Rate (Chars/Sec)

This item sets the rate (characters/second) at which the system retrieves a signal from a depressed key.

Settings: [6, 8, 10, 12, 15, 20, 24, 30]

Typematic Delay (Msec)

This item sets the delay between when the key was first pressed and when the system begins to repeat the signal from the depressed key.

Settings: [250, 500, 750, 1000]

Security Option

Selects whether the password is required every time the System boots, or only when you enter Setup.

| Setting | Description |
|----------------|---|
| Setup | Password prompt appears only when end users try to run BIOS Setup |
| System | Password prompt appears every time when the computer is powered on and when end users try to run BIOS Setup |

APIC Mode

Enables APIC (Advanced Programmable Interrupt Controller) functionality.

Settings: [Enabled, Disabled]

MPS Variation Control for OS

Settings: [1.1, 1.4]

Display Full Screen Logo

Show full screen logo during BIOS boot up process.

Settings: [Enabled, Disabled]

Display Small Logo

Show small energy star logo during BIOS boot up process.

Settings: [Enabled, Disabled]

CPU FEATURE

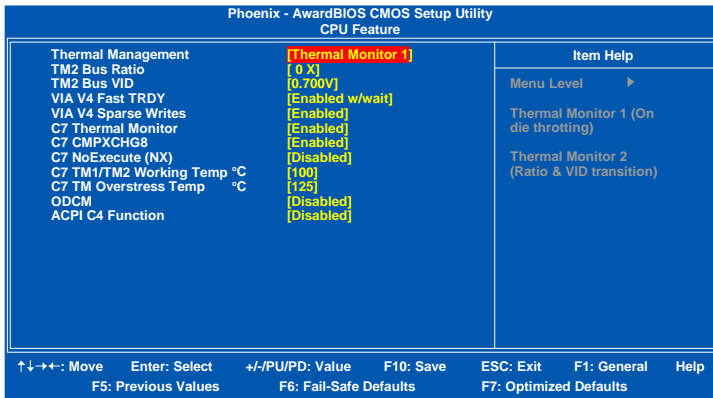

Thermal Management

This item sets CPU's thermal control rule to protect CPU from overheat.

| Setting | Description |
|-------------------|------------------------|
| Thermal Monitor 1 | On-die throttling |
| Thermal Monitor 2 | Ratio & VID transition |

TM2 Bus Ratio

This item sets the frequency (bus ratio) of the throttled performance that will be initiated when the on die sensor goes from not hot to hot.

Key in a DEC number.

Settings: [Min = 0, Max = 255]

TM2 Bus VID

This item sets the voltage of the throttled performance that will be initiated when the on die sensor goes from not hot to hot.

Settings: [0.700V, 0.716V, 0.732V, 0.748V, 0.764V, 0.780V, 0.796V, 0.812V, 0.828V, 0.844V, 0.860V, 0.876V, 0.892V, 0.908V, 0.924V, 0.940V, 0.956V, 0.972V, 0.988V, 1.004V, 1.020V, 1.036V, 1.052V, 1.068V, 1.084V, 1.100V, 1.116V, 1.132V, 1.148V, 1.164V, 1.180V, 1.196V, 1.212V, 1.228V, 1.244V, 1.260V, 1.276V, 1.292V, 1.308V, 1.324V, 1.340V, 1.356V, 1.372V, 1.388V, 1.404V, 1.420V, 1.436V, 1.452V, 1.468V, 1.484V, 1.500V, 1.516V, 1.532V, 1.548V, 1.564V, 1.580V, 1.596V, 1.612V, 1.628V, 1.644V, 1.660V, 1.676V, 1.692V, 1.708]

VIA V4 Fast TRDY

Settings: [Enabled, Enabled w/wait, Disabled]

VIA V4 Sparse Writes

Settings: [Enabled, Disabled]

C7 Thermal Monitor

Settings: [Enabled, Disabled]

C7 CMPXCHG8

Settings: [Enabled, Disabled]

C7 NoExecute (NX)

Settings: [Enabled, Disabled]

C7 TM1/TM2 Working Temp °C

This item sets the high threshold and the low threshold (lo = high-5°C).

Key in a DEC number.

Settings: [Min = 0, Max = 255]

C7 TM Overstress Temp °C

Key in a DEC number.

Settings: [Min = 0, Max = 255]

ODCM

Enables the ODCM (On Demand Clock Modulation) functionality.

Settings: [Enabled, Disabled]

ACPI C4 Function

Enables the ACPI (Advanced Configuration and Power Management Interface) C4 functionality.

Settings: [Enabled, Disabled]

HARD DISK BOOT PRIORITY

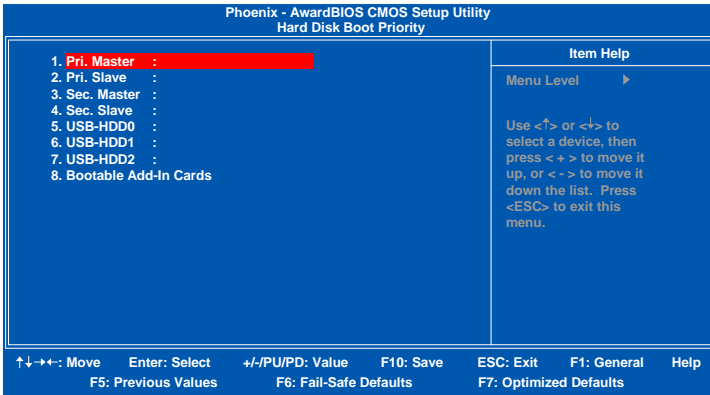

This is for setting the priority of the hard disk boot order when the "Hard Disk" option is selected in the "[First/Second/Third] Boot Device" menu item.

ADVANCED CHIPSET FEATURES

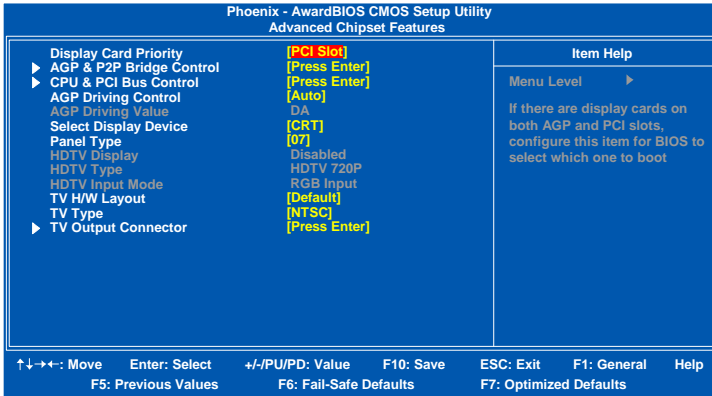

Caution:

The Advanced Chipset Features menu is used for optimizing the chipset functions. Do not change these settings unless you are familiar with the chipset.

Display Card Priority

This setting specifies which VGA card is your primary graphics adapter.

Settings: [PCI Slot, AGP]

AGP Driving Control

This item is used to signal driving current on AGP cards to auto or manual.

Settings: [Auto, Manual]

AGP Driving Value

Key in a HEX number.

Settings: [Min = 0000, Max = 00FF]

Select Display Device

This setting refers to the type of display being used with the system.

Settings: [CRT, LCD, CRT + LCD, TV, CRT + TV, LCD + TV, DVI, CRT + DVI, TV + DVI]

Panel Type

This setting refers to the native resolution of the display being used with the system.

Key in a HEX number.

Settings: [Min = 0000, Max = 000F]

TV H/W Layout

Settings: [Default, COMPOSITE + S-Video, COMP. + R/G/B, COMP. + Y/Cb/Cr, COMP. + SDTV-R.G.B, COMP. + SDTV-Y.Pb.Pr, COMPOSITE, S-Video, R.G.B, Y.Cb.Cr, SDTV – R.G.B, SDTV – Y.Pb.Pr, S-Video + R.G.B, S-Video + Y.Cb.Cr]

TV Type

This setting refers to the native resolution of the display being used with the system.

Settings: [NTSC, PAL]

AGP & P2P BRIDGE CONTROL

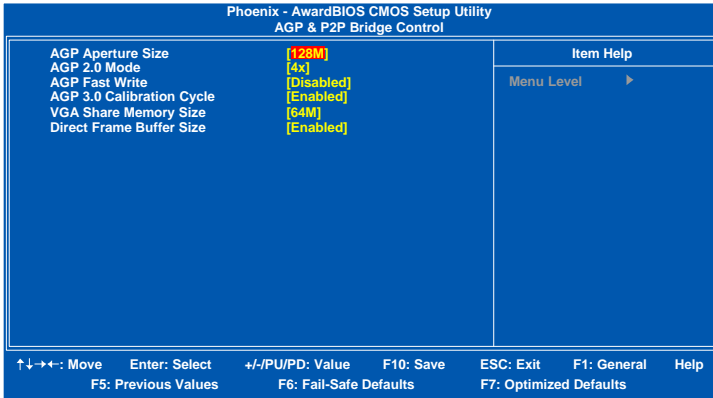

AGP Aperture Size

This setting controls how much memory space can be allocated to AGP for video purposes. The aperture is a portion of the PCI memory address range dedicated to graphics memory address space. Host cycles that hit the aperture range are forwarded to the AGP without any translation.

Settings: [32MB, 64MB, 128MB, 256MB, 512MB, 1G]

AGP 2.0 Mode

This mainboard supports the AGP 4x interface. When the AGP 4x video card is used, it can transfer video data at 1066MB/s. AGP 4x is backward compatible, leave the default 4x mode on. AGP 4x mode can be detected automatically once you plug in the AGP 4x card.

Settings: [4x, 2x, 1x]

AGP Fast Write

This item is used to enable or disable the caching of display data for the video memory of the processor.

Settings: [Enabled, Disabled]

AGP 3.0 Calibration Cycle

Settings: [Enabled, Disabled]

VGA Share Memory Size

Settings: [Disabled, 16M, 32M, 64M]

Direct Frame Buffer

Settings: [Enabled, Disabled]

CPU & PCI BUS CONTROL

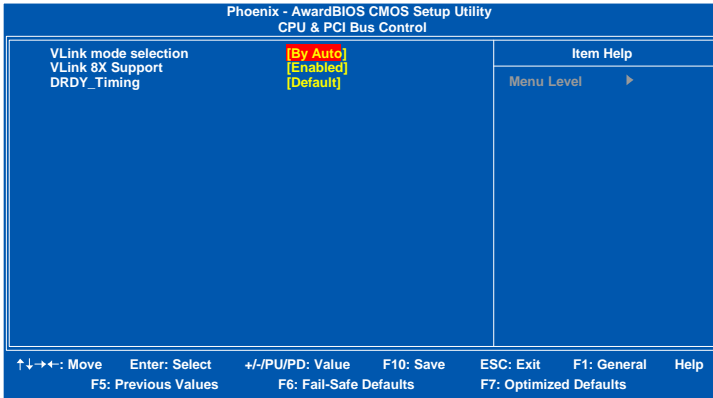

V-Link mode selection

This menu item controls the data transfer speed between the north and south bridge.

Settings: [By Auto, Mode 0~4]

V-Link 8X Support

Settings: [Enabled, Disabled]

DRDY_Timing

Settings: [Slowest, Default, Optimize]

TV OUTPUT CONNECTOR

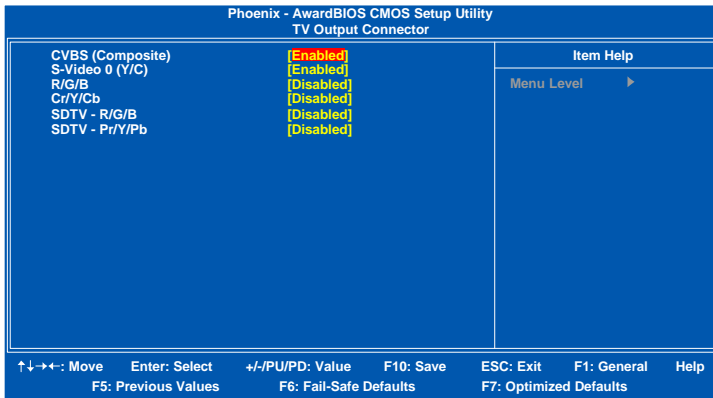
**CVBS (Composite)**

Settings: [Enabled, Disabled]

S-Video 0 (Y/C)

Settings: [Enabled, Disabled]

R/G/B

Settings: [Enabled, Disabled]

Cr/Y/Cb

Settings: [Enabled, Disabled]

SDTV-R/G/B

Settings: [Enabled, Disabled]

SDTV-Pr/Y/Pb

Settings: [Enabled, Disabled]

INTEGRATED PERIPHERALS

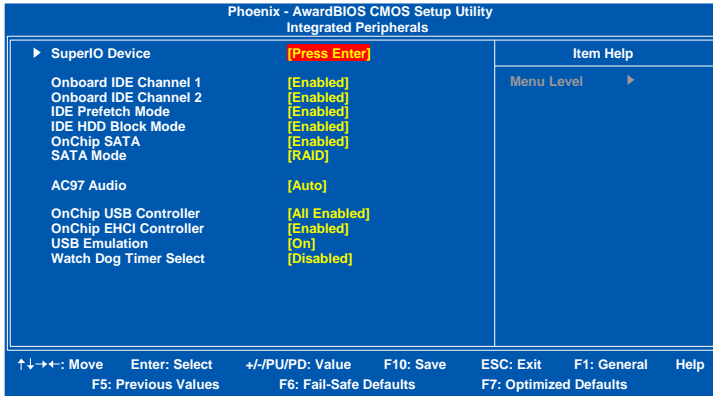

Onboard IDE Channel 1 and 2

The integrated peripheral controller contains an IDE interface with support for two IDE channels.

| Setting | Description |
|----------|-----------------------------------|
| Enabled | Activates each channel separately |
| Disabled | Deactivates IDE channels |

IDE Prefetch Mode

Settings: [Enabled, Disabled]

IDE HDD Block Mode

This allows the hard disk controller to use the fast block mode to transfer data to and from the hard disk drive. Block mode is also called block transfer, multiple commands or multiple sector read / write.

| Setting | Description |
|----------|---------------|
| Enabled | Block mode |
| Disabled | Standard mode |

OnChip SATA

Settings: [Enabled, Disabled]

SATA Mode

Serial ATA is the latest generation of the ATA interface. Serial ATA hard drives deliver transfer speeds of up to 150MB/sec.

| Setting | Description |
|---------|--|
| IDE | Supports two SATA plus two PATA hard disk drives |
| RAID | Only SATA supports RAID |

AC'97 Audio

Auto allows the mainboard to detect whether an audio device is used. If the device is detected, the onboard VIA AC'97 (Audio Codec'97) controller will be enabled; otherwise, it is disabled. Disable the controller if another controller card is being used to connect to an audio device.

| Setting | Description |
|----------|--|
| Auto | Enables onboard controller if audio device is detected |
| Disabled | Turn off onboard controller to allow external controller |

OnChip USB Controller

Settings: [All Disabled, All Enabled, 1&2 USB Port, 2&3 USB Port, 1&3 USB Port, 1 USB Port, 2 USB Port, 3 USB Port]

OnChip EHCI Controller

Settings: [Enabled, Disabled]

USB Emulation

Set this field to choose the USB emulation. When set to "OFF ", do not support any USB device on DOS. When set to "KB/MS", support USB legacy keyboard and mouse, no support USB storage. And set to "ON", support USB legacy keyboard, mouse and storage.

Settings: [OFF, KB/MS, ON]

Watch Dog Timer Select

Settings: [Disabled, 20 sec, 30 sec, 40 sec, 1 min, 2 min, 4 min,]

SUPER IO DEVICE

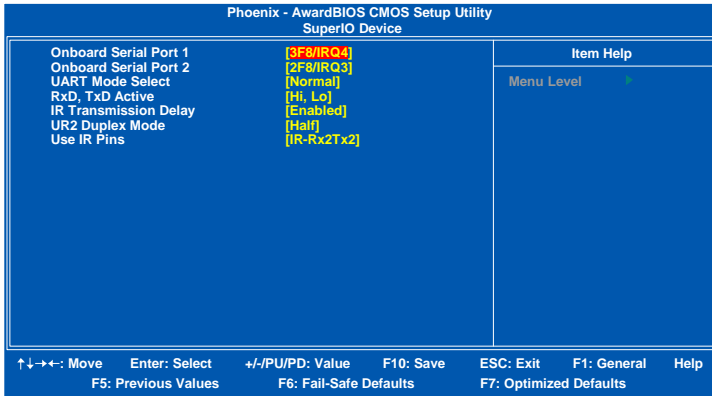

Onboard Serial Port 1/2

Sets the base I/O port address and IRQ for the onboard serial ports A and B. Selecting “Auto” allows the BIOS to automatically determine the correct base I/O port address.

| Port | Settings | | | | | |
|------|----------|------|------|------|------|------|
| 1 | Disabled | 3F8 | 2F8 | 3E8 | 2E8 | Auto |
| | | IRQ4 | IRQ3 | IRQ4 | IRQ3 | |
| 2 | Disabled | 3F8 | 2F8 | 3E8 | 2E8 | Auto |
| | | IRQ4 | IRQ3 | IRQ4 | IRQ3 | |

UART Mode Select

Settings: [IrDA, ASKIR, Normal]

RxD, Tx/D Active

Settings: [Hi,Hi, Hi.Lo, Lo.Hi, Lo.Lo]

IR Transmission Delay

Settings: [Disabled, Enabled]

UR2 Duplex Mode

Settings: [Full, Half]

Use IR Pins

Settings: [RxD2.TxD2, IR-Rx2Tx2]

POWER MANAGEMENT SETUP

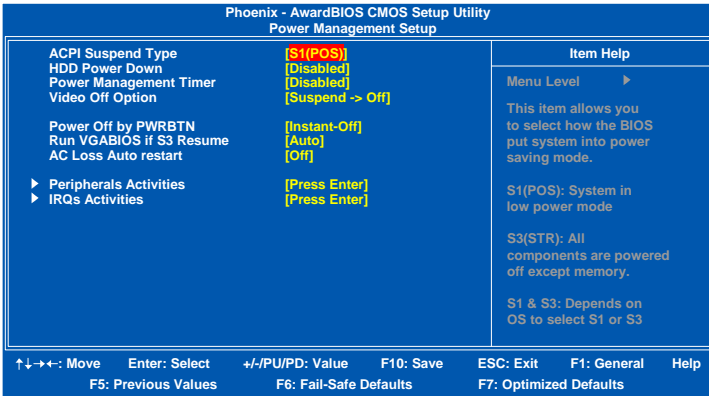

ACPI Suspend Type

| Setting | Description |
|---------|--|
| S1(POS) | S1/Power On Suspend (POS) is a low power state. In this state, no system context (CPU or chipset) is lost and hardware maintains all system contexts. |
| S3(STR) | S3/Suspend To RAM (STR) is a power-down state. In this state, power is supplied only to essential components such as main memory and wakeup-capable devices. The system context is saved to main memory, and context is restored from the memory when a "wakeup" event occurs. |
| S1 & S3 | Depends on the OS to select S1 or S3. |

HDD Power Down

Sets the length of time for a period of inactivity before powering down the hard disk.

Settings: [Disabled, 1~15(minutes)]

Power Management Timer

Set the idle time before system enters power saving mode. ACPI OS such as Windows XP will override this option.

Settings: [Disabled, 1/2/4/6/8/10/20/30/40(minutes), 1(hour)]

Video Off Option

Select whether or not to turn off the screen when system enters power saving mode, ACPI OS such as Windows XP will override this option.

| Setting | Description |
|----------------|---|
| Always On | Screen is always on even when system enters power saving mode |
| Suspend -> Off | Screen is turned off when system enters power saving mode |

Power Off by PWRBTN

This field configures the power button on the chassis.

| Setting | Description |
|-------------|--|
| Delay 4 Sec | System is turned off if power button is pressed for more than four seconds |
| Instant-Off | Power button functions as a normal power-on/-off button |

Run VGABIOS if S3 Resume

Select whether to run VGA BIOS if resuming from S3 state. This is only necessary for older VGA drivers.

Settings: [Auto, Yes, No]

AC Loss Auto restart

The field defines how the system will respond after an AC power loss during system operation.

| Setting | Description |
|------------|--|
| Off | Keeps the system in an off state until the power button is pressed |
| On | Restarts the system when the power is back |
| Former-Sts | Former-Sts |

PERIPHERAL ACTIVITIES

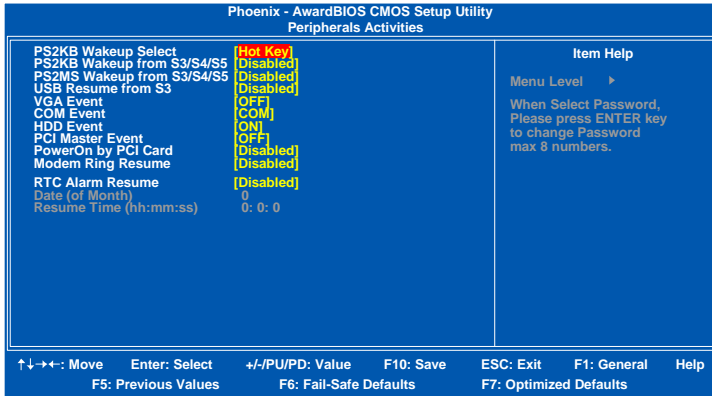

PS2KB Wakeup Select

When selecting "Password", press <Page Up> or <Page Down> to change password. The maximum number of characters is eight. "PS2MS Wakeup from S3/S4/S5" and "PS2KB Wakeup from S3/S4/S5" will be disabled while changing the password.

Settings: [Hot Key, Password]

PS2KB Wakeup from S3/S4/S5

Sets a Hot Key to restore the system from the power saving mode to an active state.

Settings: [Disabled, Ctrl+F1, Ctrl+F2, Ctrl+F3, Ctrl+F4, Ctrl+F5, Ctrl+F6, Ctrl+F7, Ctrl+F8, Ctrl+F9, Ctrl+F10, Ctrl+F11, Ctrl+F12, Power, Wake, Any Key]

PS2MS Wakeup from S3/S4/S5

Enables any mouse activity to restore the system from the power saving mode to an active state.

Settings: [Disabled, Enabled]

USB Resume from S3

Enables activity detected from USB devices to restore the system from a suspended state to an active state.

Settings: [Disabled, Enabled]

VGA Event

Enables the power management unit to monitor VGA activities.

Settings: [Off, On]

COM Event

Decide whether or not the power management unit should monitor serial port (COM) activities.

Settings: [None, COM]

HDD Event

Enables the power management unit to monitor hard disk activities.

Settings: [Off, On]

PCI Master Event

Enables the power management unit to monitor PCI master activities.

Settings: [Off, On]

PowerOn by PCI Card

Enables activity detected from any PCI card to power up the system or resume from a suspended state. Such PCI cards include LAN card, onboard LAN controller, onboard USB ports, etc.

Settings: [Disabled, Enabled]

Modem Ring Resume

Enables any Wake-on LAN or Ring-In signals from the Ethernet or modem to restore the system from a suspended state to an active state.

Settings: [Disabled, Enabled]

RTC Alarm Resume

Sets a scheduled time and/or date to automatically power on the system.

Settings: [Disabled, Enabled]

Date (of Month)

The field specifies the date for "RTC Alarm Resume".

Resume Time (hh:mm:ss)

The field specifies the time for "RTC Alarm Resume".

IRQs ACTIVITIES

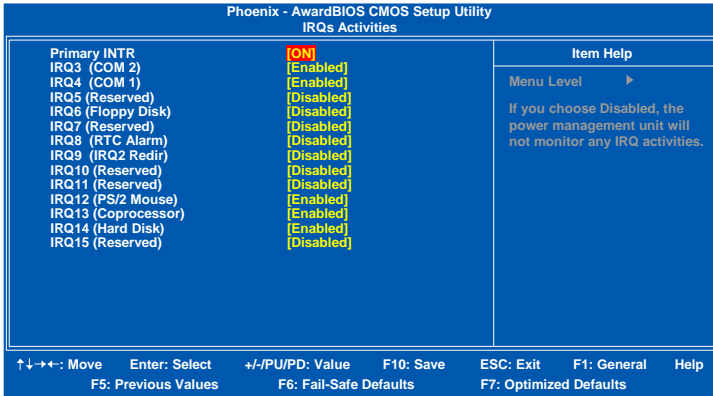

Primary INTR

Restores the system to an active state if IRQ activity is detected from any of the enabled channels

Settings: [Off, On]

IRQ3~IRQ15

Enables or disables the monitoring of the specified IRQ line. These fields are only available if "Primary INTR" is on.

Settings: [Enabled, Disabled]



Note:

IRQ (Interrupt Request) lines are system resources allocated to I/O devices. When an I/O device needs to gain attention of the operating system, it signals this by causing an IRQ to occur. After receiving the signal, when the operating system is ready, the system will interrupt itself and perform the service required by the IO device.

PNP/PCI CONFIGURATIONS

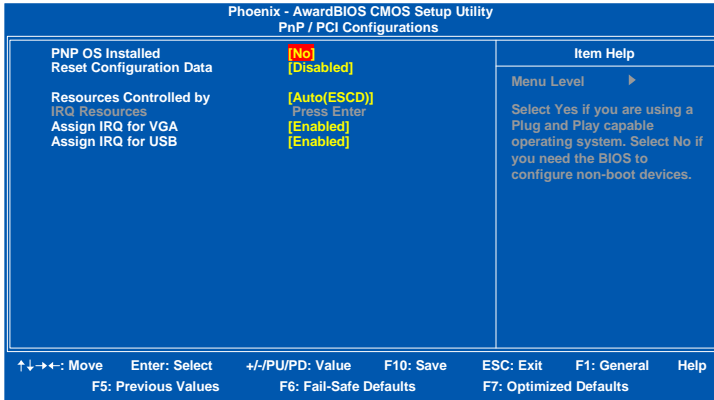

Note:

This section covers some very technical items and it is strongly recommended to leave the default settings as is unless you are an experienced user.

PNP OS Installed

| Setting | Description |
|---------|--|
| Yes | BIOS will only initialize the PnP cards used for booting (VGA, IDE, SCSI). The rest of the cards will be initialized by the PnP operating system |
| No | BIOS will initialize all the PnP cards |

Reset Configuration Data

This field should usually be left "Disabled".

| Setting | Description |
|----------|--|
| Enabled | Resets the ESCD (Extended System Configuration Data) after exiting BIOS Setup if a newly installed PCI card or the system configuration prevents the operating system from loading |
| Disabled | Default setting |

Resource Controlled By

Enables the BIOS to automatically configure all the Plug-and-Play compatible devices.

| Setting | Description |
|------------|--|
| Auto(ESCD) | BIOS will automatically assign IRQ, DMA and memory base address fields |
| Manual | Unlocks "IRQ Resources" for manual configuration |

Assign IRQ For VGA/USB

Assign IRQ for VGA and USB devices.

Settings: [Disabled, Enabled]

IRQ RESOURCES

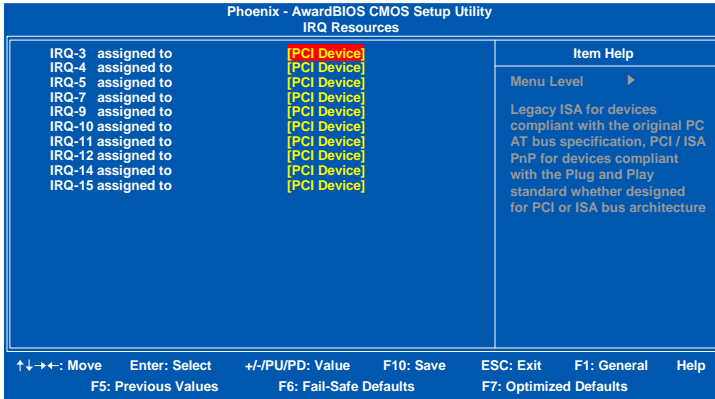

Note:
The items are adjustable only when “Resources Controlled By” is set to “Manual.”

IRQ Resources list IRQ 3/4/5/7/9/10/11/12/14/15 for users to set each IRQ a type depending on the type of device using the IRQ.

| Setting | Description |
|------------|--|
| PCI Device | For Plug-and-Play compatible devices designed for PCI bus architecture |
| Reserved | The IRQ will be reserved for other requests |

PC HEALTH STATUS

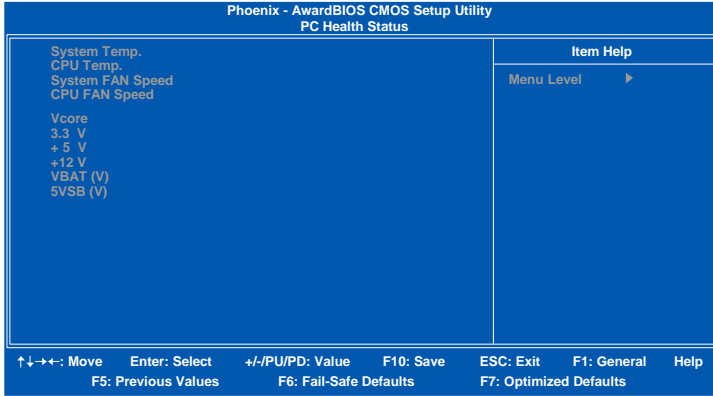

The PC Health Status displays the current status of all of the monitored hardware devices/components such as CPU voltages, temperatures and fan speeds.

FREQUENCY / VOLTAGE CONTROL

| Phoenix - AwardBIOS CMOS Setup Utility Frequency / Voltage Control | | Item Help |
|---|---------------|--------------|
| DRAM Clock | [By SPD] | |
| DRAM Timing | [Auto By SPD] | |
| SDRAM CAS Latency [DDR/DDR2] | 2.5/4 | Menu Level ▶ |
| Bank Interleave | Disabled | |
| Precharge to Active(Trp) | 4T | |
| Active to Precharge(Tras) | 07T | |
| Active to CMD(Trcd) | 4T | |
| REF to ACT/REF(Trfc) | 25T | |
| ACT(0) to ACT(1) (TRRD) | 3T | |
| Read to Precharge(Trtp) | [2T] | |
| Write to Read ClkD(Twr) | [1T/2T] | |
| Write Recovery Time(Twr) | [4T] | |
| DRAM Command Rate | [2T Command] | |
| RDSAIT mode | [Auto] | |
| RDSAIT selection | 03 | |
| Auto Detect PCI Clk | [Enabled] | |
| Spread Spectrum | [0.25%] | |

↑↓→←: Move Enter: Select +/-/PU/PD: Value F10: Save ESC: Exit F1: General Help
 F5: Previous Values F6: Fail-Safe Defaults F7: Optimized Defaults

DRAM Clock

The chipset supports synchronous and asynchronous mode between host clock and DRAM clock frequency.

Settings: [100 MHz, 133 MHz, 166 MHz, 200MHz, 266MHz, 333MHz, By SPD]

DRAM Timing

The value in this field depends on the memory modules installed in your system. Changing the value from the factory setting is not recommended unless you install new memory that has a different performance rating than the original modules.

Settings: [Manual, Auto By SPD, Turbo, Ultra]

SDRAM CAS Latency [DDR/DDR2]

This item is for setting the speed it takes for the memory module to complete a command. Generally, a lower setting will improve the performance of your system. However, if your system becomes less stable, you should change it to a higher setting. This field is only available when "DRAM Timing" is set to "Manual".

Settings: [1.5/2, 2/3, 2.5/4, 3/5]

Bank Interleave

This item is for setting the interleave mode of the SDRAM interface. Interleaving allows banks of SDRAM to alternate their refresh and access cycles. One bank will undergo its refresh cycle while another is being accessed. This improves performance of the SDRAM by masking the refresh time of each bank. This field is only available when "DRAM Timing" is set to "Manual".

Settings: [Disabled, 2 Bank, 4 Bank, 8 Bank]

Precharge to Active (Trp)

This field is for setting the length of time it takes to precharge a row in the memory module before the row becomes active. Longer values are safer but may not offer the best performance. This field is only available when "DRAM Timing" is set to "Manual".

Settings: [2T, 3T, 4T, 5T]

Active to Precharge (Tras)

This field is for setting the length of time it a row stays active before precharging. Longer values are safer but may not offer the best performance. This field is only available when "DRAM Timing" is set to "Manual".

Settings: [05T, 06~20T]

Active to CMD (Trcd)

This field is only available when "DRAM Timing" is set to "Manual".

Settings: [2T, 3T, 4T, 5T]

REF to ACT / REF (Trfc)

This field is only available when "DRAM Timing" is set to "Manual".

Settings: [08T, 09~71T]

ACT(0) to ACT(1) (TRRD)

This field is only available when "DRAM Timing" is set to "Manual".

Settings: [2T, 3T, 4T, 5T]

Read to Precharge (Trptp)

Settings: [2T, 3T]

Write to Read CMD (Twtr)

Settings: [1T/2T, 2T/3T]

Write Recovery Time (Twr)

Settings: [2T, 3T, 4T, 5T]

DRAM Command Rate

This field is for setting how fast the memory controller sends out commands. Lower setting equals faster command rate.

Settings: [2T Command, 1T Command]

**Note:**

Some memory modules may not be able to handle lower settings.

RDSAIT Mode

Settings: [Manual, Auto]

RDSAIT Selection

Key in a HEX number.

Settings: [Min = 0000, Max = 003F]

Auto Detect PCI Clk

Settings: [Disabled, Enabled]

Spread Spectrum

When the mainboard's clock generator pulses, the extreme values (spikes) of the pulses creates EMI (Electromagnetic Interference). The Spread Spectrum function reduces the EMI generated by modulating the pulses so that the spikes of the pulses are reduced to flatter curves.

Settings: [Disabled, 0.20%, 0.25%, 0.35%]

LOAD FAIL-SAFE DEFAULTS

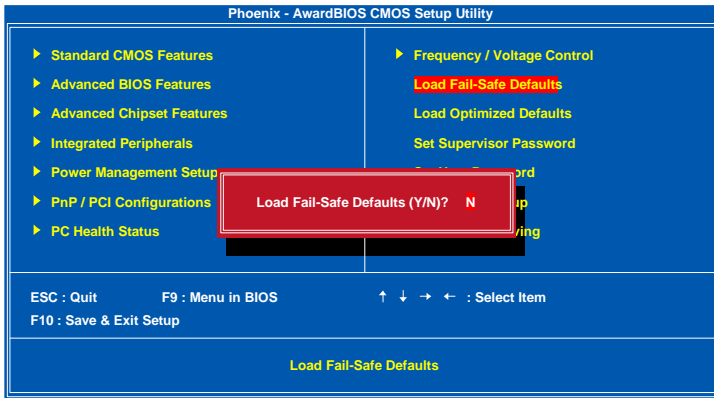

This option is for restoring all the default fail-safe BIOS settings. These values are set by the mainboard manufacturer to provide a stable system with basic performance.

Entering "Y" loads the default fail-safe BIOS values.

LOAD OPTIMIZED DEFAULTS

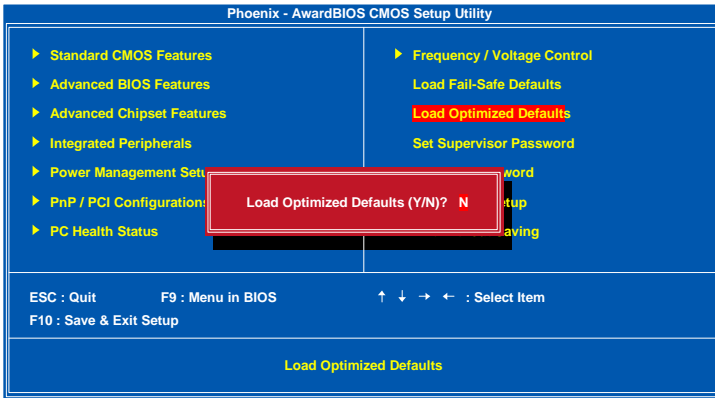

This option is for restoring all the default optimized BIOS settings. The default optimized values are set by the mainboard manufacturer to provide a stable system with optimized performance.

Entering "Y" loads the default optimized BIOS values.

SET SUPERVISOR / USER PASSWORD

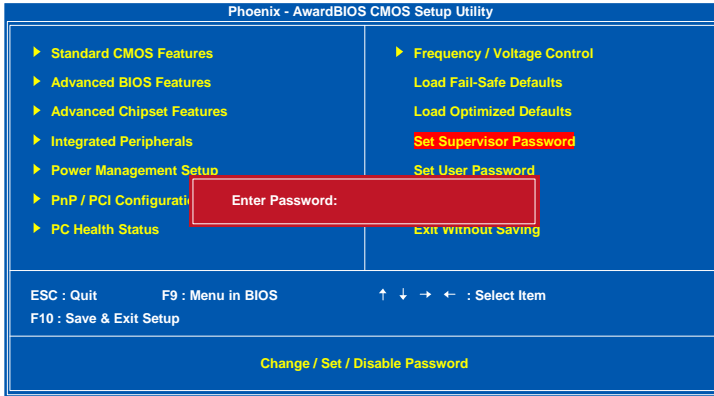

This option is for setting a password for entering BIOS Setup. When a password has been set, a password prompt will be displayed whenever BIOS Setup is run. This prevents an unauthorized person from changing any part of your system configuration.

There are two types of passwords you can set. A supervisor password and a user password. When a supervisor password is used, the BIOS Setup program can be accessed and the BIOS settings can be changed. When a user password is used, the BIOS Setup program can be accessed but the BIOS settings cannot be changed.

To set the password, type the password (up to eight characters in length) and press <Enter>. The password typed now will clear any previously set password from CMOS memory. The new password will need to be reentered to be confirmed. To cancel the process press <Esc>.

To disable the password, press <Enter> when prompted to enter a new password. A message will show up to confirm disabling the password. To cancel the process press <Esc>.

Additionally, when a password is enabled, the BIOS can be set to request the password each time the system is booted. This would prevent unauthorized use of the system. See "Security Option" in the "Advanced BIOS Features" section for more details.

SAVE & EXIT SETUP

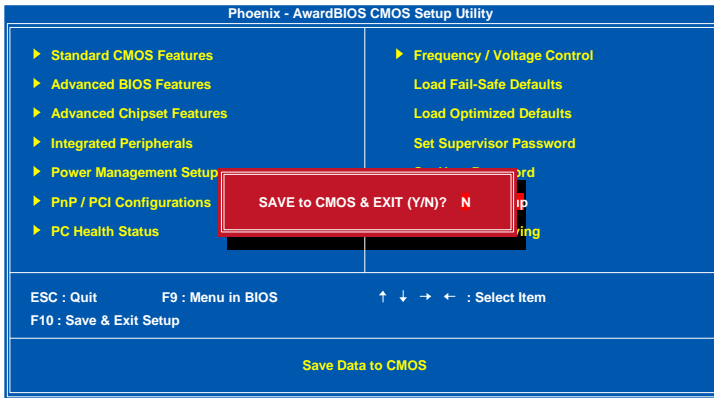

Entering "Y" saves any changes made and exits the program.

Entering "N" will cancel the exit request.

EXIT WITHOUT SAVING

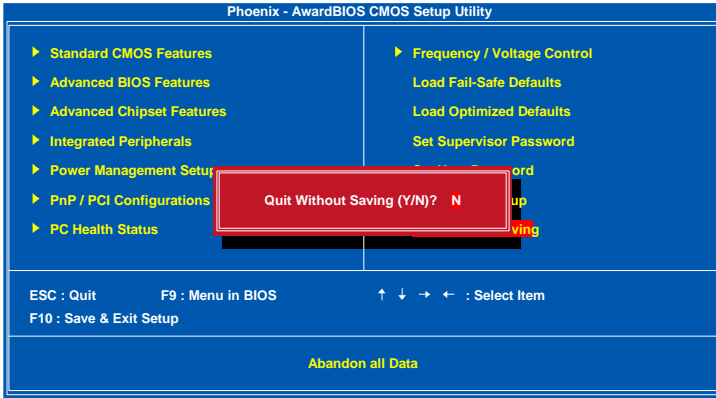

Entering "Y" discards any changes made and exits the program.

Entering "N" will cancel the exit request.

CHAPTER 4

Driver Installation

This chapter gives you brief descriptions of each mainboard driver and application. You must install the VIA chipset drivers first before installing other drivers such as audio or VGA drivers. The applications will only function correctly if the necessary drivers are already installed.

DRIVER UTILITIES

Getting Started

The mainboard includes a Driver Utilities CD that contains the driver utilities and software for enhancing the performance of the mainboard. If the CD is missing from the retail box, please contact the local dealer for the CD.



Note:

The driver utilities and software are updated from time to time. The latest updated versions are available at <http://www.viaembedded.com/>

Running the Driver Utilities CD

To start using the CD, insert the CD into the CD-ROM or DVD-ROM drive. The CD should run automatically after closing the CD-ROM or DVD-ROM drive. The driver utilities and software menu screen should then appear on the screen. If the CD does not run automatically, click on the "Start" button and select "Run..." Then type: "D:\Setup.exe".

**Note:**

D: might not be the drive letter of the CD-ROM/DVD-ROM in your system.

CD CONTENT

- ☒ **VIA 4in1 Drivers:** Contains VIA ATAPI Vendor Support Driver (enables the performance enhancing bus mastering functions on ATA-capable Hard Disk Drives and ensures IDE device compatibility), AGP VxD Driver (provides service routines to your VGA driver and interface directly to hardware, providing fast graphical access), IRQ Routing Miniport Driver (sets the system's PCI IRQ routing sequence) and VIA INF Driver (enables the VIA Power Management function).
- ☒ **VIA Graphics Driver:** Enhances the onboard VIA graphic chip.
- ☒ **VIA Audio Driver:** Enhances the onboard VIA audio chip.
- ☒ **VIA USB 2.0 Driver:** Enhances VIA USB 2.0 ports.
- ☒ **VIA LAN Driver:** Enhances the onboard VIA 10/100M LAN chip.
- ☒ **VIA GLAN Driver:** Enhances the onboard VIA Giga LAN chip.
- ☒ **VIA RAID Driver:** Support for SATA RAID devices.